

POLE MOUNTING

①

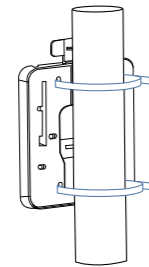

Slide the cable ties through the mounting plate and fasten them around the pole.

②

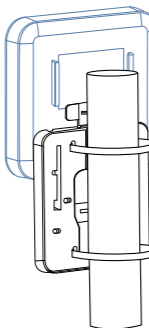

Slide the Access Point over the mounting plate.

③

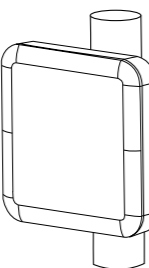

Your Access Point is now safely tied to the pole.

FCC COMPLIANCE NOTICE

Any changes or modifications not expressly approved by the party responsible for compliance could void your authority to operate the equipment.

Note: This equipment has been tested and found to comply with the limits for a Class B digital device, pursuant to part 15 of the FCC Rules. These limits are designed to provide reasonable protection against harmful interference in a residential installation. This equipment generates, uses and can radiate radio frequency energy and, if not installed and used in accordance with the instructions, may cause harmful interference to radio communications. However, there is no guarantee that interference will not occur in a particular installation. If this equipment does cause harmful interference to radio or television reception, which can be determined by turning the equipment off and on, the user is encouraged to try to correct the interference by one or more of the following measures:

- Reorient or relocate the receiving antenna.
- Increase the separation between the equipment and receiver.
- Connect the equipment into an outlet on a circuit different from that to which the receiver is connected.
- Consult the dealer or an experienced radio/TV technician for help.

This equipment complies with FCC RF radiation exposure limits set forth for an uncontrolled environment. This equipment should be installed and operated with a minimum distance of 20 centimeters between the radiator and your body.

IC COMPLIANCE NOTICE

This product meets the applicable Innovation, Science and Economic Development Canada technical specifications.

Ce produit répond aux spécifications techniques applicables à l'innovation, Science et Développement économique Canada.

This device complies with Industry Canada's licence-exempt RSSs. Operation is subject to the following two conditions:

- (1) This device may not cause interference; and
- (2) This device must accept any interference, including interference that may cause undesired operation of the device.

Le présent appareil est conforme aux CNR d'Industrie Canada applicables aux appareils radio exempts de licence. L'exploitation est autorisée aux deux conditions suivantes:

- (1) L'appareil ne doit pas produire de brouillage, et
- (2) L'utilisateur de l'appareil doit accepter tout brouillage radioélectrique subi, même si le brouillage est susceptible d'en compromettre le fonctionnement.

This device complies with the ISED radiation exposure limit set forth for an uncontrolled environment. This device should be installed and operated with minimum distance 20cm between the radiator & your body. This transmitter must not be co-located or operating in conjunction with any other antenna or transmitter.

Cet équipement est conforme avec l'exposition aux radiations ISED définies pour un environnement non contrôlé. Cet équipement doit être installé et utilisé à une distance minimum de 20 cm entre le radiateur et votre corps. Cet émetteur ne doit pas être co-localisées ou opérant en conjonction avec une autre antenne ou transmetteur.

CE COMPLIANCE NOTICE

This equipment complies with EU radiation exposure limits set forth for an uncontrolled environment. This equipment should be installed and operated with minimum distance 20 cm between the radiator and your body.

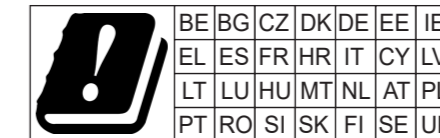

PA1200

Quick Start Guide

INTRODUCTION

Thank you for purchasing the PA1200. This Quick Start Guide is designed to guide you through the installation process.

PACKAGE CONTENTS

1. Access Point
2. Mounting options (ceiling, wall, pole, T-rail)
3. Open cable housing lid
4. Closed cable housing lid
5. Screws and screw plugs for various surfaces
6. Cable ties

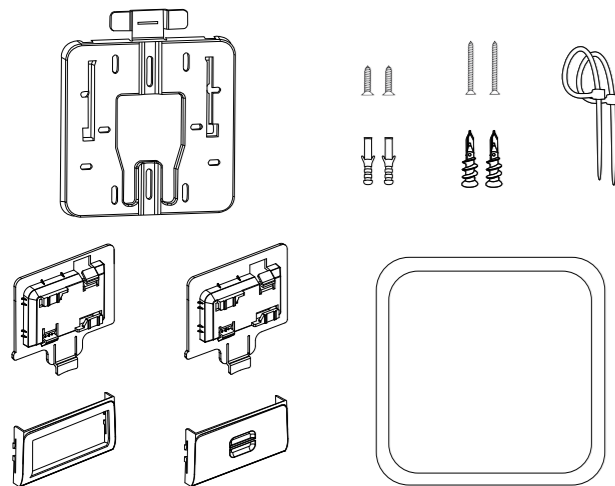

CLOUD MANAGEMENT

1. Sign up at console.plasma-cloud.com.
2. Create your first organisation by navigating to **Organisations** → **Create new organisation**. Fill in the form and click **Create**.
3. You can now create your first network. Navigate to **Networks** → **Create new network**, fill in the form and click **Create**.
4. Setup your network by navigating to **Settings** → **Network**.
5. Create and configure your first SSID by navigating to **Settings** → **SSIDs** → **Create new SSID**.
6. Go back to Overview and click on the map to add your first Access Point.

The last point can be repeated to add as many Access Points as needed.

You can now plug-in your Access Point and connect it to the Internet. **The Plasma Cloud configuration only takes a few seconds!**

PHYSICAL INSTALLATION

This Access Point is designed to be installed virtually anywhere and can operate between 0°C ~ 40°C (32°F ~ 104°F). It comes with a set of mounting options that can be used to install this device on various surfaces such as: ceilings, walls, poles and T-rails of various sizes.

This Access Point can be powered by:

1. a 12-24V/1A DC power adapter
2. a 48-54V/0.5A PoE injector (802.3af/at)



SUPPORT

Feel free to visit <https://support.plasma-cloud.com> for additional technical guidance or to contact our support department.

T-RAIL MOUNTING

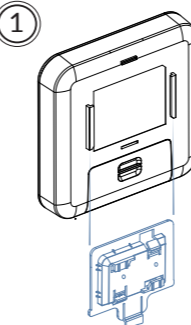
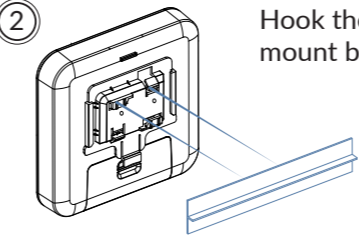
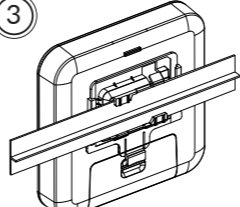
1. Slide the T-rail mount into the slot of the Access Point.

2. Hook the stationary end of the mount bracket to the T-rail.

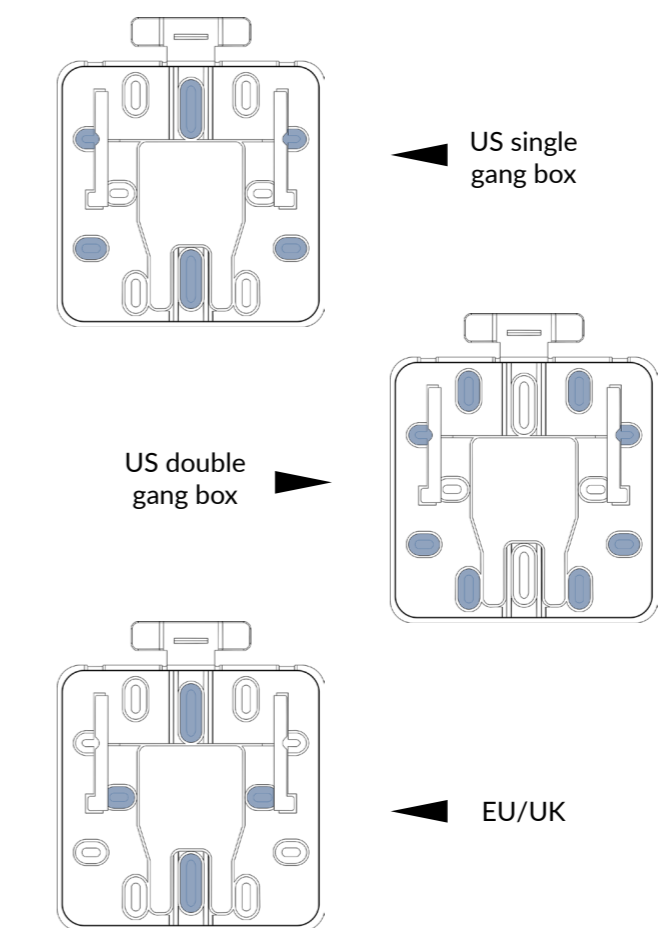
3. Your Access Point is now safely clipped to the T-rail.

MOUNTING BRACKET OVERVIEW

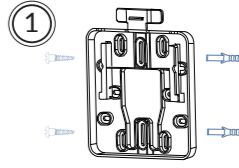
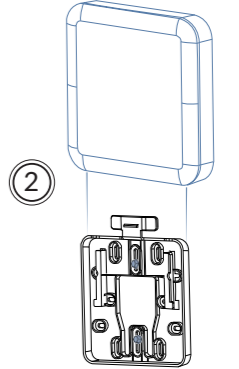

WALL MOUNTING

1. Use the provided screws and screw plugs to fix the mounting plate on the wall.

2. Slide the Access Point over the mounting plate.

3. Your Access Point is now safely attached to the wall.
